

The Clarkston News

Hoag & Hoag
Springport, Mich

Vol. 40 - No. 46

The Clarkston (Mich.) News

Thursday, July 16, 1970

1 Section

10 cents



Jim's Jottings

By Jim Sherman

The only problem I've ever had with eating is not getting enough. When I sit down to the table I don't like to get up until I'm full.

A couple of weeks ago, some friends invited us out for dinner. I had tickets for a church banquet that night. The friends asked that I use the tickets before coming to their house. I did, too, because I embarrassed Hazel.

Invariably I will have a sandwich before going to friends for dinner.

However, the "fat and forty" phrase got to me... nearly four years later. I have always prided myself on maintaining the same weight I had when 28. That was 217. Since Christmas 18 pounds have been added, spread rather evenly front and back.

Now, for the first time, dieting has begun. Do you readers realize that you have been spared from any comment about dieting for these many volumes?

Of course, I've no diet experience, but that doesn't stop me from having opinions. On dieting the opinion is that all you need to do is not eat too much. No pills, no doctor consultations, no extra exercising. Look at the money I'll save.

All the money I've saved is about as visible as the weight I've lost. At this writing I've taken off eight pounds. Strange that the weight taken off doesn't come from the same place it went on.

The eight pounds must have been internal and inside me is a cavity. That cavity is my stomach, but it didn't contract. Some doctors would have you think that the stomach reduces in size as food is used for energy. I'll never believe it.

The only thing that keeps me on this diet is stubbornness. I get so hungry I go to bed or go work in the yard to get away from the refrigerator. There is a constant gnawing. It's worse than giving up cigars.

Naturally, Hazel, my mate, is doing everything she can to help. My favorite meal is probably a chuck roast well done with dark brown gravy and potatoes with bread and gravy on the side. That's what I got the first night of my dieting.

That's the last time I spoke to her, which has made her happy because usually the only thing I say is, "When do we eat?"

I also find that my temper is



The only ones who could possibly have enjoyed Friday's weather.

Village gets capacity

Through the cooperation of the Township, Clarkston village now has capacity in a sewer line to carry the effluent out of town.

Up until Tuesday night the Village had no way of discharging sewer collections.

A contract between the two local units of government was signed at their regular meetings last week.

Now the Village can proceed with a contract with the County DPW for laying lines (laterals) within the Village limits. Until the Village had been given capacity in the interceptor the bonding companies wouldn't finance the sewer project.

The Township had capacity to give to the Village because they had contracted for 10 percent of the Clinton-Oakland Interceptor when it was started. They took Village residents into consideration at that time.

The Village's proportion is for about 9 percent of the 10 percent. The contract calls for Village residents to pay the same

shorter than usual. Might as well make everyone else in the family miserable. When Dad suffers, everyone suffers.

But soon it will be over, I'll be back to 217. What is beginning to bother me is... will I remember how I've suffered losing this weight or will I resume consuming enough each meal for two?

Maybe someone can tell me why, when I've been so hungry for so long and my clothes feel loose, why do scales show that I haven't lost weight for two full days? If it's a plateau, when does the next valley appear? Do you other watchers of weight have a similar problem?

costs as Township residents on a user basis.

One thing left for the Village Council to pass is an ordinance covering sewer maintenance, hook-up time, charges, etc. Financial consultant Billy S. Farnum will be working with the Village on resident cost figures.

Mahar resigns Council seat

Village trustee Jim Mahar, of Miller Road, resigned from the Clarkston Council Monday night. His letter noted the press of personal business. He is owner of Mahar Productions, a filming company.

Mahar was first elected to the Council in 1965 and was re-elected in 1967 and 1969. He has lived in Clarkston since 1960.



Little League teams swung into competitive action the week of June 15th. These members of the Midwest Flyers hope a little practice will make "almost" perfect players.

Trailer park zoning stalled again

By Jim Sherman

Case 129 has been returned to the Planning Commission.

Everything has to have a number and in this case the number 129 belongs to a rezoning request by Morris Singer and Philip Kaplan. They have asked that their 115 acres on Clintonville Road near I-75 be zoned for mobile home park from agriculture.

The Independence Township Board returned case 129 to the planners Tuesday night. In his motion that resulted in the action, clerk Howard Altman asked the planners to review a letter of May 14 and memorandum of May 11 from professional consultants Vilican-Leman and Associates, of Southfield.

The memo suggests new wording in the purpose section of the mobile home park ordinance. The letter recommended a halt in zoning changes until there was further planning.

Both of the V-L correspondence came after the Planning Commission decision recommending rezoning of the 115 acres.

At their last meeting the Township Board voted to table case 129 after the May 14 letter was referred to by Altman. Supervisor Duane Hursfall said at that time he was unfamiliar with the letter and

voted with other board members to table the zoning request.

Prior to the Board vote, Jack Raisin of Walters Lake, and whose wife owns property neighboring the Singer-Kaplan acreage, presented a petition signed by residents near the site in question. The petition opposed the rezoning.

Another zoning request was denied Tuesday night by the Board. This was from Robert Dieball and Don Arsen and involved property at the corner of Pine Knob road and Clarkston-Orion road. The request was for a change from R1A to Multiple.

Rec. program in full swing

The Independence Township Recreation Summer Program is well under way. The program this year is under the direction of Paul Tungate.

With Midgets, Widgets and PeeWees all counted together there are 39 teams competing in the Little League's baseball program.

In addition to the baseball program playground activities are in full swing at the Andersonville, Bailey Lake, Clarkston and Sashabaw Elementary School playgrounds.

The playground activities are under the direction of Cathy Richardson, a June graduate of Western Michigan and a veteran of 6 years experience in the program, who is ably assisted by Mark Cowan.

The playgrounds offer both group and individual activities. They range from games, races, sports participation to crafts and reading.

All playgrounds are supervised from 8:30 a.m. until noon from Monday through Friday.

Counselors at Andersonville playground are Ed Dowd, Kay Beattie and Bev Hanson. Bailey Lake is supervised by Beth Cowan, Claudia Sawyer and Steve Snover. Cindy Gerber, Val LePere, Karen MacDougall, Kurt Richardson and Jeff Richardson are on duty at Sashabaw and Cindy Porritt, Marcia Fahrner, Sue Griffiths, Keith Dutcher and Rich Schouns are at Clarkston.

The directors of the program encourage all children from 5 to 12 to join in the fun and activities. "It isn't too late to join the fun," they say. "We'll be in operation until July 31."

Lightening strikes area residences

Two area homes were struck by lightning on July 8 at approximately 3:50 p.m. according to Independence Township Fire Department records.

It struck the fuse box at the home of Joseph Peason at 6705 Townview and put it out of order.

At the same time it struck the home of G. Brancheau, around the corner, at 6677 Langle. Here it struck the electric range and flashed into a cooking vessel.

No fire resulted and electrical service was restored in both homes.

Mrs. Ralph Hickerson of 9252 Sashabaw was taken to the hospital with possible 2nd degree burns on her feet, according to a Fire Department spokesman. Some grease in a pan on the stove in her home caught fire and spilled as she tried to remove it.

obituaries

Jerome Mullegan

Jerome E. Mulligan, 36, of 1660 Standish Court, Bloomfield Hills, who is well known in the Clarkston area, died as a result of injuries received in an automobile accident in New York State on July 12.

Mr. Mulligan was a graduate of the U of M Law School, and a director of the Oakland County Bar Association. He was the editor of the Latches Publication. He belonged to the Pontiac Rotary Club, the Elks Lodge No. 810, Oakland Hunt Club, Oakland County Sportsman's Club, Huron River Hunting and Fishing Club and the Saltair Yacht Club in Fire Island, New York.

Mulligan was a member of the Episcopal Church of the Advent in

Orchard Lake.

He is survived by his wife, Ruelba, his mother Mrs. Mary Mulligan of Bay Shore, New York and 3 children, Elizabeth, Jerome and Kevin, all at home.

Also surviving is his brother, Arthur Mulligan, of Plymouth.

Funeral services were held from the Church of the Advent. Arrangements were made by the Lewis E. Wint Funeral Home.

Ruth Skibowski

Ruth Skibowski of Pontiac died after a short illness on July 3. She was 73. Mrs. Skibowski is survived by her sons, Merrill of Clarkston and Charles of Pontiac.

Also surviving are 2 grandchildren, 3 great grandchildren, a brother, Hugh Casey of Pontiac and a sister, Mrs. Viva Skibowski of Rochester.

Funeral services were held from the Sharpe-Goyette Funeral Home on July 6 and burial was in Lakeview Cemetery.



Behind the Counter FROM KEITH HALLMAN

An elderly housewife recently walked into her local pharmacy, painfully holding her left hand. She raised a crudely bandaged forefinger and asked her pharmacist to "give me something" for the digit that had been caught in a car door.

He looked at the badly cut finger and shook his head. "You'd better not treat that yourself," he said. "You should see a doctor at once."

The wound required three stitches, the woman's hand was saved and possible complications avoided—thanks to the intelligent advice of the pharmacist.

In emergencies, it's still the druggist who is often called on for first aid. Every hour in the day, people approach the nation's 110,000 or more community pharmacists, seeking advice that ranges from problems of skin care to a pain in the leg.

While he refers conditions of a serious nature to your physician, the pharmacist supplements the doctor—making sure that the prescribed medicine is used properly, for instance. So it's not surprising that U.S. pharmacists receive over 170,000 phone calls from physicians—to verify the name of a drug, or to check the recommended dosage, or to see if a new product is available.

The druggist, the doctor, the dentist, the podiatrist—along with all other members of the health team—are working together in the best interests of the community they serve.

Hallman Apothecary
4 SOUTH MAIN 625-1700

Custom Floor Covering

This is the home of Red Carpet Service . . . and blue and green . . . so don't be nervous. We can furnish EVERY color . . . and protect your hard earned dollar!

PHONE 625-2100 5930 M-15
OPEN MONDAY THRU FRIDAY 8-5
SATURDAYS FROM 8-1

BORROW UP TO \$1000 FROM DIAL. CALL US FOR THE MONEY TODAY.

Examples:

Months to repay	Amount financed	Monthly payment	Total of payments	Annual percentage rate
24	\$ 358.42	\$ 20.00	\$ 480.00	29.79%
30	\$ 664.16	\$ 30.00	\$ 900.00	25.02%
36	\$ 999.91	\$ 38.24	\$1376.64	22.11%

Dial Finance

The one for the money

Pontiac

10 W. Huron

334-0541

Drayton Plains

4496 Dixie Highway

673-1221



OXFORD OVERHEAD DOOR SALES CO.

GARAGE DOORS — Sales, Service, Repairs of Doors and operators.

George Shick, Jr., Larry Moore, 427 Tanview, 628-4555

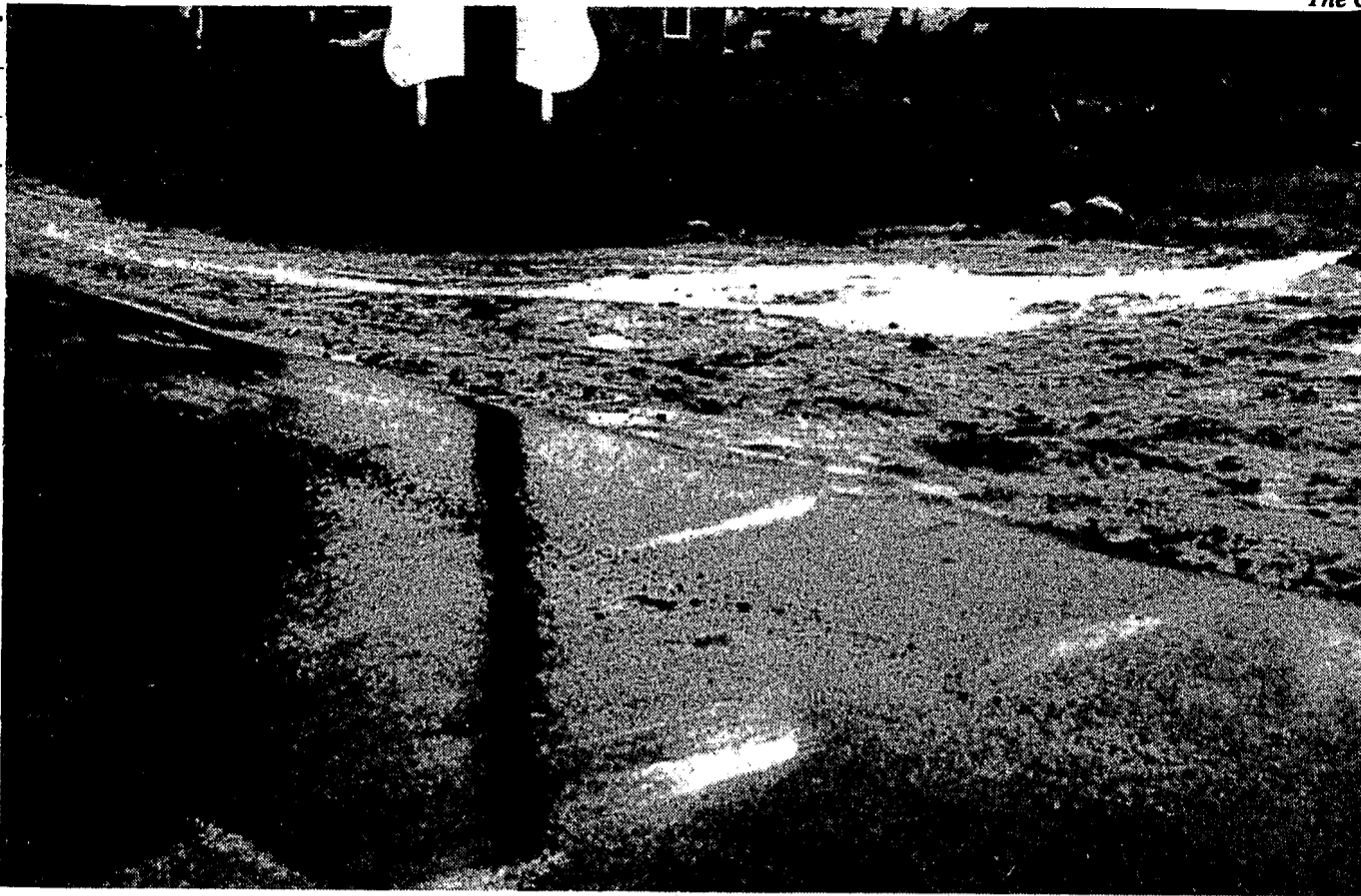

RUN OFF—Some residents along Holcomb Street, south of Miller Road, are getting a land, or lawn, fill with each heavy rain. Source of the clay-filled rain water is Deerfield Farms subdivision. Several months ago the Village agreed to allowing the developers to put in a holding basin for the water, but if it's in, it wasn't doing the job at 11:30 a.m. Friday. The sludge washed across yards and into the Mill Pond. Some attempt was made to dam up the entrance, but water came through. The problem came up for discussion at Monday night's Council meeting. President Donald Cooper said he would attempt to contact the developers again to see if they would correct the draining. If no action is forthcoming legal action would be considered the Council said.

Honors list

Ann Latoza, whose home is at 5920 Warbler, received straight A's in the school of Psychology at Michigan State University this past term.

Three other Clarkston students maintained a 3.5 (B plus) average. They are: Gary R. McMillan in the school of Theatre, Patricia Mulcrone, Business Law and Office Administration and James B. Rausch, Veterinary Medicine.

THE CLARKSTON NEWS
Published every Thursday at
5 S. Main, Clarkston, Mich.
James A. Sherman, Publisher
Jean Sura, Editor
Subscription price \$4.00
per year, in advance
phone: 625-3370
Entered as second class matter, September
4, 1931, at the Post Office at Clarkston,
Michigan 48016.

MEET THE CANDIDATES

FREE DEMOCRATIC PICNIC
JULY 26 1:00-7:00 p.m.

GAMES — POP — PRIZES

6151 Pine Knob Road
Chicken Furnished
Bring One Dish & Whole Family

Awarded silver star



Army Specialist Four Frank S. Everingham, 20, (right) son of Mr. and Mrs. Eugene Everingham, of 8747 Lakeview, Clarkston, receives the Army Commendation Medal during ceremonies near Tay Ninh, Vietnam. Everingham received the award for meritorious service as a radio telephone operator in Company D, 3rd Battalion, 22nd Infantry of the 25th Infantry Division. Shortly after, he was awarded the Silver Star award.

Army Specialist 4, Frank S. Everingham, 20, son of Mr. and Mrs. Eugene Everingham of Lakeview, recently received the Silver Star award near Tay Ninh, Vietnam.

The award was received for gallantry in action while engaged in military operations against a hostile force in Vietnam.

Excerpts from the text of the award stated that while on a reconnaissance mission, the unit came under intense small arms fire from a large enemy force on the slopes of Nui Cao Mountain.

When the platoon leader became wounded among others, Specialist Everingham took control of the element.

With disregard for his own safety he exposed himself to a hail of enemy fire as he placed his men in strategic fighting positions and also assisted in the evacuation process.

Everingham attended Groves High School in Birmingham and completed his high school work while in service. His tour of duty will be completed on July 28.

The Everingham family moved to Clarkston from Lake Orion in March.

Honors list

Claudia Jean Gordon, a sophomore who lives on Wompole Drive, was among 1,722 students who have been named to

the scholastic honors list at Central Michigan University for the 1970 spring semester.

To be eligible for the scholastic honors list, a student must have a cumulative grade average of "B" or better for his entire college career.

FIRST FEDERAL SAVINGS

Offers

Highest Rate of Interest

on Readily Available
FUNDS

5%

PASSBOOK SAVINGS

COMPOUNDED AND PAID QUARTERLY!

No advance notice required for
withdrawal on your Passbook Savings!

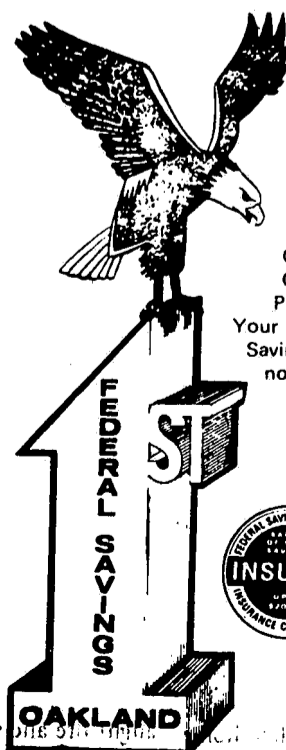

Savings
Certificate
Customers
Please Note:
Your New Certificate
Savings Books are
now available.



James Rohm
5799 Ortonville Rd.
Clarkston

Earn First Federal's high rate of interest
on ALL OF YOUR SAVINGS

... START TODAY! SAVINGS CERTIFICATES

in the amounts of:
\$5,000 earn 5% interest
when held for 6 months

\$10,000 earn 5% interest
when held for 12 months

\$10,000 earn 6% interest
when held for 2 years

Lake Orion	Pontiac
Waterford	Drayton Plains
Walled Lake	Rochester
Union Lake	Clarkston
Northeast Pontiac	Milford

See the Amazing Parade of Top Talent
FREE at the 1970 Michigan
STATE FAIR
AUG. 28 - SEPT. 7

- THREE DEGREES
- MARK WILSON and the Magic Land of Allokazam
- YOUNG CANADIANS & The RAIDERS WITH MARK LINDSAY
- JOHNNY CASH
- ROY CLARK & HEE HAW STARS
- JAMES DARREN
- 5th DIMENSION
- FRIENDS OF DISTINCTION
- ART LINKLETTER
- CHARLEY PRIDE
- PAUL REVERE
- ARTHUR GODFREY
- HURRICANE HELL DRIVERS
- OLIVER

Gate Adm. \$1.50; children 8 thru 12, 50 cents; children under 8 admitted free when accompanied by an adult

editorial page

THE REAL POLLUTERS



Less talk-more action

Every paper or magazine that you read these days has articles discussing pollution. Ecology has become a passing by-word that every first grade kid can discuss with understanding and in depth. There are about as many ideas about the whole problem as there are people.

If words, written and spoken, could cure the problem we would have the whole solution right in our mouths. We would have attained

"If It Fitz . . ."

Poor Old Joe Single



By Jim Fitzgerald

And then I wrote . . .

Out of the Jimmy Hoffa trial, of all places, came another sneaky jab at my hero, the bachelor. A news item lamented the lonely time the 12 jurors had, locked away from the rest of the world for 6 weeks. With which I will not argue. But then this insidious propagandist added:

"Juror Patrick Haverty had the easiest time of it. He was the LONE BACHELOR in the group." (The caps are mine; so is the neck pain).

There is a one-sided war going on in the world. All the married people are fighting to get all the single men down the middle aisle in a rented suit. For some reason I don't understand, the bachelors are not fighting back with vigor. As a result, Joe Single is easy prey for the nice couple around the corner who know this lovely girl who Joe should meet, he really should.

So Joe meets her, under the influence of free steaks and booze. His married friends show off their pretty children,

well-bribed to behave for the first time since Christmas eve. Mr and Mrs talk glowingly about delicious dinners, Sunday papers read in bed, and a light in the window. No mention is made of mortgages, dirty diapers or chocolate fingerprints on favorite books. The usual sighing remarks are made about "How do you stand it all alone in that tiny apartment over the poolroom, Joe?" In no time, the guy is hooked.

And then Joe can say: "I never knew what living was until I got married, but then it was too late."

I am not here to knock marriage per se. It is an ok type of life and I wouldn't sell my family for any amount of swinging freedom. Lease or rent, maybe, but I would always insist on retaining ownership. God, in his almighty wisdom, invented Love, a formless substance which somehow cements the most unlikely relationships and can make a husband forget any number of undies soaking in the bathroom sink or sticky candy in his favorite chair.

But it is time that some married man told Joe Single that he is not necessarily an unfortunate slob, merely treading water until some doll comes along to show him what swimming really is. As a man always interested in seeing a pat on every back, and a kick in every seat, I am volunteering to answer such "poor bachelor" nonsense as planted in the Hoffa trial story.

Why was it easier for Patrick Haverty, rather than the married jurors, to be isolated for 6 weeks? The average reader, well brainwashed by the unfair climate which prevails, would answer: "Well heck, those married people were lonesome for their spouses and children. Patrick didn't have anyone to be lonesome for, so he didn't mind being cooped up."

Such an attitude assumes that there is little in this world to interest Joe Single. Despite being married 132 years, I can remember slamming my front door carelessly at 3 a.m.; I know that Joe doesn't have to go home when the library closes. I could,

in fact, list a countless number of goodies available to Joe but I won't, as I hate to make myself cry.

It is not my intention to tell Joe Single what he should do; only what he shouldn't. And the biggest thing he shouldn't do is fall for the malarky his married friends pass out with the dinner invitations. Keep eating in restaurants, Joe. You may think it costs more but you don't know what costs are until you push an overflowing cart up to the A&P checkout counter.

Joe shouldn't be rushed. A nice age to get married is 30; almost as nice as 40. And Joe shouldn't worry about the beach being swept clean of pebbles. New ones come in with every tide.

There is much to be said for living alone, making your own decisions, and watching the clock for no one except yourself. Such a life affords a peace and solitude; a time for quiet thinking and reading; a type of quiet contentment rarely available to the married man.

Unless he gets jury duty.

ecological purity months ago.

We can ballyhoo all we want to about industry and government taking steps to cure the ill but the problem still rests with us, — the people.

When did you last toss paper or other litter out of your car window? When did you last check the exhaust system of your car, incinerator or furnace outlet? Do you reason that your little bit won't hurt.

What kind of soap do you use? Do you conclude that it is bad for the population in general to use something but the little that you contribute to the overall picture won't affect it?

Industry and government are spending millions of dollars to clean up the environment . . . with billions more needed.

Who made it dirty in the first place? And who must pay for the cleaning?

The answer is simple: people, you and me.

Think about it every day. Do something yourself to improve the situation. We are the ones who can help cure the problem and it sure is worth trying.

Deserve more

Police officers are entitled to a better shake than they have been getting recently from the news media.

Watching TV recently I have noticed that network news programs give the impression sometimes that the men who are hired to enforce the laws in our state and country are often made out to be villains, and the criminal is depicted as a "good guy."

The time is long overdue for the general public to stand up in support of our law enforcement officials.

If we continue to allow lawlessness it will only cause the days of a "police state" to come about quicker. And if those days arrive it will not be the fault of the police.

The blame will lie squarely on those who failed to support the police and on the lawless who seem bent on destroying the very ideals which have given them so much freedom.

I support those who believe enough in something to dissent in an orderly way. Dr. Martin Luther King was a good example of someone who didn't believe in all the laws, but did not break the law to have it changed.

There must be law. Without it no one has any rights.

"Forgery charge to scare us"

There has been no further action on the restraining order filed against Independence Township involving petitions for a referendum on a zoning change on Walton road.

That was the information given by Keith Humbert at Tuesday's Township Board meeting. Humbert was asked the status of the suit by Township Clerk Howard Altman, following a question from the audience.

Humbert is chairman of Clarkston Gardens subdivision association, the group which launched the petition drive.

The zoning change was sought by the real estate appraisal brokerage firm of Anderson, Frome and Lipshour.

The Board approved the change to multiple dwellings, citizens objected with the petition and the restraining order was obtained to stop the clerk from verifying the petition signatures.

The charge of forgery was included in the suit. Humbert said Tuesday, "They have charged forgery on the petitions, I guess to scare us (into dropping the push for a referendum) or to run us into the

ground financially."

He said the Garden's attorney said the case may take over a year to settle.

Humbert asked Altman if the Township would defend him (Altman) in court since Altman was named in the suit

as approving false signatures. The Board agreed that they would defend the actions of their clerk.

Humbert said he didn't feel the Association should cover the legal costs of defending Altman.

OPEN HOUSE: Sunday, July 19, 1970, 2 till 5. Birdland Subdivision, Clarkston. Directions: Dixie Hwy - to Maybee - North to Kingfisher to property. (Watch for Open signs)

Planners' Agenda

There will be a meeting of the Independence Township Planning Commission at the Township Hall on Thursday, July 16 at 7:30 p.m.

A public hearing is scheduled on the proposed rezoning of 11.91 acres from single family and limited industrial use to highway commercial, and 54.47 acres to multiple residence.

The property, in Section 29, lies along Dixie Highway midway between the White Lake Road and M-15 intersection. There are 372 apartment units proposed in the requested multiple plan.

Two new presentations will be made to the Commission.

Schatz and Hotchkiss will request the rezoning from suburban farms to multiple dwellings of approximately 10 acres in Section 26 which lies between I-75 and Waldon Road. The property is on the east

side of Pine Knob Road.

The developers propose to build multiples with 72 units.

The second proposal will be made by James Rasin. The application requests the rezoning of the Risenger property in Section 36 on Clintonville Road. The request asks that the approximately 20 acres be rezoned from residential to multiple family.

The plan would provide for 200 units to be built in town houses and rental apartments.

The plan of Joseph Yingling which was tabled previously has been revised and will be reconsidered.

Yingling requests that approximately 10 acres in Section 2 be rezoned from agriculture to residential to provide 4 parcels for single family residences. The property is on the corner of Pine Knob Road and Whipple Lake Road.



KINGFISHER - For the elite, large wooded lot comes with this beautiful brick and aluminum home. Attached two car garage, 3 bedrooms, bright kitchen with built-ins. Full basement. Land contract terms.

MARK REAL ESTATE CO.

Phone 332-0124

1702 S. Telegraph Pontiac

Klann undergoes survival training

Michigan Wing Headquarters Civil Air Patrol in Detroit has announced the selection of a Clarkston youth to undergo six days of rugged survival training at the Air Force Academy in Colorado Springs, Colo.

Cadet Major Robert C. Klann, son of Mr. and Mrs. Charles Klann, 6682 Pear St., was among 60 outstanding Civil Air Patrol cadets chosen from across the nation to attend the course beginning July 10.

This tough, adventurous training was designed to provide cadets with survival

techniques which someday could save a life, possibly their own.

Civil Air Patrol annually sponsors specialized courses for its boy and girl cadets each summer. Civil Air Patrol, official auxiliary of the Air Force, boasts a national volunteer membership of some 70,000 cadets and senior members.

Its mission includes providing emergency services in times of National and local disasters, flying search and rescue missions authorized by the Air Force, and conducting an aerospace education program.

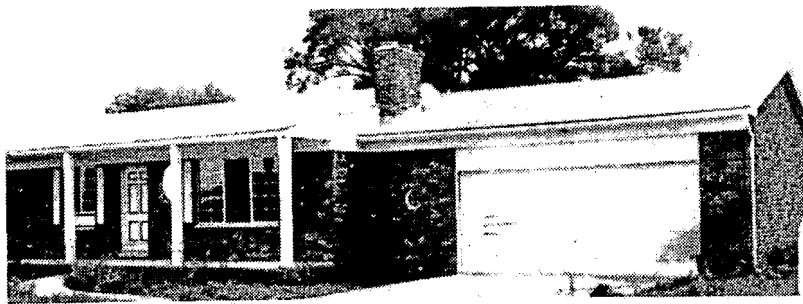

THE KEY TO GOOD LIVING—\$26,500 reproduction on your lot or ours. 3 bedrooms, 1½ ceramic baths, all formica kitchen with built ins, first floor laundry room, & full walk out basement. Models shown by appointment or Open every Sunday.

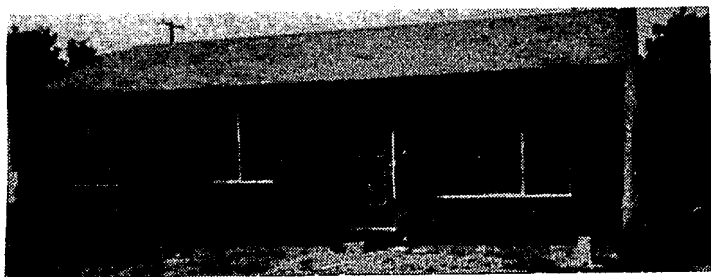

LESS THAN RENT—That's Right! \$16,200 reproduction on your lot or ours. 3 bedrooms, carpeting thru out, ceramic bath with vanity, all formica kitchen with built ins, and much, much more. Models shown by appointment or Open every Sunday.

Dorris
AND SON
REALTORS

Phone 674-0324

"Established in 1930"

2536 Dixie Highway, Pontiac

IMMEDIATE HOUSING

All Set Up

Ready to Move In

On Lots In Our Park

10x50 Hillcrest \$3995⁰⁰
AIR & TIP OUT

12x50 Star \$4995⁰⁰

10x57 New Moon \$3995⁰⁰

12x60 Buddy \$5995⁰⁰
3 BEDROOM 1½ BATHS

Brand New Marlette Expando \$7995⁰⁰

MANY EXTRAS

Low Lot Rent

Marlette YOUR AUTHORIZED DEALER



Parkhurst Mobile Home Sales & Court

1540 LAPEER RD.

693-8812

LAKE ORION

Letters to the Editor

Needs to care

concerned about our welfare.
Keith A. Humbert

Dear Editor:

Independence Township has a careless Supervisor. On several occasions at the Tuesday meeting he stated he cared less about what happens in Section Six of the Township.

As Supervisor he should bleed when we bleed, and cry when we cry. He could even rejoice when we rejoice, if there was much to rejoice about. As representative of the people, he should be much more

Hello

July 11, 1970

Dear Editor:

Please renew our subscription and mail it to: Louis Champeau MM3/B56 68 74 USN 70-24/Nuc. Pwr. Sch./Mare Island/Vallejo, California 94592.

Louis would like you to say "hi" to all his friends for him.

Yours truly,
Claire Champeau

briefly told

The annual Ice-cream Social at the St. Augustine House at 3316 East Draher Road in Oxford will be held on July 19. The scooping and entertainment will begin at 2 p.m., according to reports, and will continue until 6.

Musical groups from as far away as Chicago will provide an interlude. Fr. Arthur Kreinheder suggests that picnic

suppers be brought and enjoyed on the grounds.

The Michigan State Police will hold their 16th annual auction of confiscated, recovered and unclaimed merchandise beginning at 8:30 a.m., August 13 on the grounds at department headquarters,

South Harrison Road, East Lansing.
About 2,000 items will be offered for sale.

The phone numbers to call for "Jobs

for Teens" for the next 2 weeks are: Sue Kelley, 625-4228; Gwen Wilton, 625-2009; Pat Ripley, 625-2215; Adele Powell, 625-2329; Barb Hamaker, 625-4041.

TOURING MICHIGAN?

Pick up your

1970 Michigan Map

FREE

at our office.

King's Insurance Agency

23 SOUTH MAIN 625-2651



SASHABAW UNITED PRESBYTERIAN CHURCH

THIS WEEK'S Spiritual Message

FROM

The Rev. Mark H. Caldwell



CHANGEOVER TIME

Mid-July is often changeover time in the auto industry. The old model is closed out and preparation is made for the new model. For some workers this means several weeks off from work whether as vacation time or just being laid off. It would make quite a difference which case prevailed for a worker.

In one situation this would be a time of apprehensive waiting - for the worker laid off-to count the weeks until he might be re-hired, wondering whether his resources would hold out long enough.

In the other situation - the vacation - it might be a welcome relief from routine, a chance to take a trip or do something special which couldn't be fitted into the regular schedule.

In either case there is a big

change in family patterns during the time which can be a constructive opportunity or a disaster. The factors which make the difference start with the economic one, but don't stop there. They include either despair or hope, either time wasted or time turned to alternate activity.

There is "for everything a season, and a time for every matter under heaven... a time to plant and a time to pluck up what is planted... a time to weep and a time to laugh... a time to seek and a time to lose;... what gain has the worker from his toil?" That was the ancient Biblical preacher Ecclesiastes talking. Then came One who claimed to be "Lord of the Sabbath" and of all our days. Let Him show us a better way.

ANDERSONVILLE
COMMUNITY CHURCH
10350 Andersonville
Rev. Wallace Duncan
Worship - 11:00 a.m.

CALVARY LUTHERAN
CHURCH
6805 Bluegrass Drive
Rev. Arlon K. Stubbe
Worship - 11:00 a.m.

EPISCOPAL CHURCH
OF THE RESURRECTION
6490 Clarkston Road
Rev. Alexander Stewart
Worship: 8:00 & 10:00

CLARKSTON CHURCH
OF GOD
54 South Main
C. J. Chestnutt
Worship - 11:00 a.m.

CLARKSTON UNITED
METHODIST CHURCH
6600 Waldon Road
Rev. Frank Cozadd
Worship - 10:00 a.m.

DIXIE BAPTIST
CHURCH
8585 Dixie Highway
Rev. Paul Vanaman
Worship - 11:00 a.m.

FIRST BAPTIST CHURCH
5972 Paramus
Worship - 11:00 a.m.

NEW HOPE BIBLE
CHURCH
5311 Sunnyside
Rev. Eldon Mudge
Worship - 11:00 a.m.

ST. DANIEL'S CHURCH
Holcomb at Miller Rd.
Father Francis Weingartz
Masses: 8:30 & 10:30

SASHABAW UNITED
PRESBYTERIAN
5331 Maybee Road
Rev. Caldwell
Worship - 10 a.m. - 11 a.m.

FREE METHODIST
CHURCH OF DRAYTON
HEIGHTS
5482 Maybee at Winell
Rev. Cranston
Worship - 11:00 a.m.

GOOD SAMARITAN
SPIRITUALIST CHURCH
5401 Oak Park
Clarkston
Worship - 7 p.m.

THE SALVATION ARMY
29 Buffalo Street
Brigadier Clarence Critzer
Worship - 11:00 a.m.

THIS SPIRITUAL MESSAGE IS SPONSORED BY THE FOLLOWING BUSINESS ESTABLISHMENTS

AL'S HARDWARE
5880 Dixie Highway
BERG CLEANERS
6700 Dixie Highway
BOB'S HARDWARE
27 South Main

CLARKSTON STANDARD
148 North Main
DEER LAKE LUMBER
7110 Dixie Highway
HALLMAN APOTHECARY
4 South Main

HAHN CHRYSLER-PLYMOUTH
6673 Dixie Highway
HOWE'S LANES
6696 Dixie Highway
HAUPT PONTIAC
North Main

ROY BROTHERS
6756 Dixie Highway
SAVOIE INSULATION
6561 Dixie Highway
TALLY HO RESTAURANT
6726 Dixie Highway

McGILL & SONS HEATING
6506 Church Street

A Thriving Garden STARTS HERE

TIPS

from the Clarkston Farm and Garden Club

Hardy chrysanthemums will make a better showing if they are given extra feeding at this time. Mums stay hungry and thirsty and should be fed once a month. Many mum growers use acid plant food on their plants. Mums should not be pinched back after the middle of July.

July is the month to transplant iris. Take your divisions from the outside of the plant, cut tops to about six inches, dust your rhizomes with sulphur before replanting.

Wisteria may be pruned now, also roots trimmed for plants that don't bloom. This is done by taking a spade and cutting around the parent plant so that the strength goes into the flowering canes.

Hemerocallis (our day lillies) can be divided when in bloom or later. When the

plants get too large there are less blooms, so it is advisable to separate every three or four years.

Cut flower spikes off coleus plants. It is the colorful foliage that makes the greatest show. When flowers are permitted to form, leaf formation is retarded.

Delphinium should be cut back after their first bloom. They will flower again in September or October.

With the coming of hot weather, raise the mower blades so that the grass is not cut lower than 2 inches.

Pick your faded flowers from petunias, marigolds, geraniums and all annual flowers, and they will continue to bloom.

Brinker's
FOR ALL
YOUR PLUMBING NEEDS

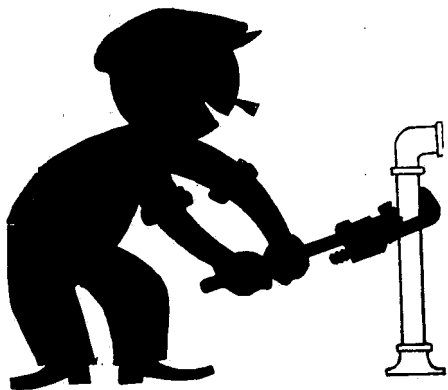

- DE-HUMIDIFIERS
- Faucets
- Softners
- Iron filters
- Baseboard
- Water pumps
- Disposals
- Hot water heaters
- Bathroom fixtures
- Hot water boilers

Brinker's
Plumbing Heating
4686 DIXIE HIGHWAY
DRAYTON PLAINS
OR 3-2121



Happy reading to our new friends:

- W. Koop
- Raymond W. Carlson
- M. Parker Bates Jr.
- W. J. Kerby
- Janet Vollbach
- Ward Dunston
- Gordon Booker
- Richard S. Marshall

Welcome back to our old friends:

- Edward J. Raby
- Jack Jyleen
- S. H. Darling
- Richard E. Price
- C. H. Lippincott
- Jane English
- Walton Robbins
- Albert Petersen
- Charles W. Klann
- Mr. & Mrs. L. L. DeClerq
- Arthur Klemm
- Robert Anthony
- Beatrice J. Smith
- Mrs. Norman Davison
- Jerome Galligan
- B. L. Lytell
- John V. Bassett
- Wm. Pfohlert
- Paul McCracken
- John Roda
- Sherwood Pretznov
- Evelyn LaPlante
- Mrs. Hazen Atkins
- Thomas Wilson
- Robert L. Furman
- Leo Armstrong
- Eva Stauter
- William Terry
- Elroy Trim

PONTIAC BUSINESS INSTITUTE

Summer Mid-Term — July 27
Speed writing — Key Punch

333-7028 — Enroll NOW!

Plane crashes

2 escape injury

A plane carrying 2 men crashed near the corner of Sashabaw and Pelton Monday evening, and luckily no one was injured. The single engine plane, a Stinson, was piloted by John Teachworth, 43, of 4736 Summer Hill, Drayton Plains.

He told Michigan State Police engine trouble developed and he headed the plane toward the field. Teachworth said he ran out of space in the field and had to nose the plane over to avoid hitting a house.

Considerable damage was done to the plane when it came to a stop on its top.

However, neither Teachworth nor his passenger, Thomas Kidd, 23, of 3510 Fort St., Pontiac was injured.

The forced landing took place at 7:05 p.m.

Montcalm AUTO GLASS CO.

ORIGINAL EQUIPMENT
SAFETY GLASS
FOR REPLACEMENT
INSTALLATION

263 West Montcalm, Pontiac
Phone 335-9204

NOW SEMI-PRIVATE

PAINT CREEK Golf and Country Club

693-9933



PRIME STARTING TIMES AVAILABLE

OPEN GOLF-PRACTICE AREAS-LESSONS PGA
Beautiful Spacious New Clubhouse
Facilities for Parties, Banquets
\$2.25 Daily \$2.75 Weekends

DIRECTIONS FROM CLARKSTON:
M-15 to Clarkston Road. Clarkston Road to Baldwin,
left on Baldwin to Coats Road, right off Coats Road
onto Stanton. Club just before Newman Road.



GO NOW!

SEE AND DRIVE
INTERNATIONAL

TRUCKS, PICK-UPS, SCOUTS

SCOUT ALL-WHEEL DRIVE
MAKES DOUBLY SURE
YOU CAN GO ANYWHERE

Milosch
Chrysler-Plymouth

677 S. Lapeer Rd., Lake Orion 693-8341

YOUR ASSURANCE IS
INSURANCE

protect your home



Our insurance policy for the home covers the house, its fixtures and other private buildings on your premises . . . against fire, other hazards.

COMPLETE INSURANCE SERVICE

HUTTENLOCHER, KERNS & NORVELL, INC.
1007 WEST HURON, PONTIAC 681-2100

Builds chair for crippled boy

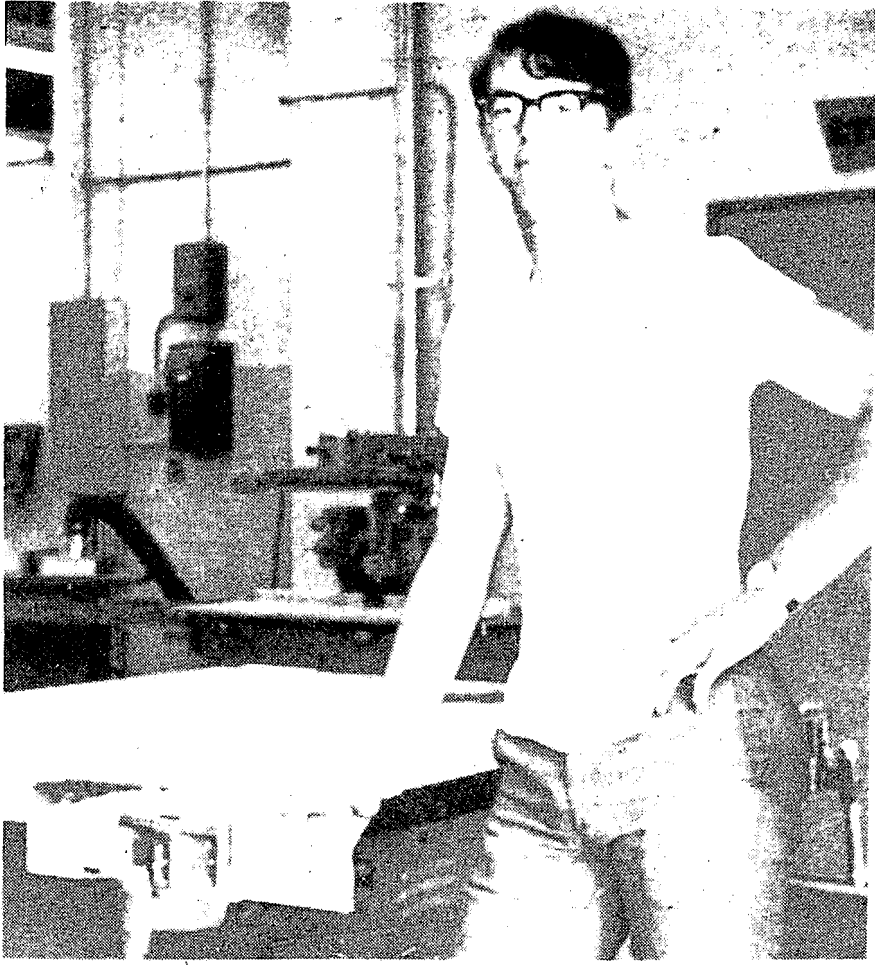

Randy Erb, 17, shows the area in the Industrial Arts Department at the Clarkston High School where he built the orthopedic chair for Kurt Cooper.

By Jean Sura

The Clarkston News gets some unusual requests. This was one with which we were happy to comply.

"I'd like for the whole community to know the fine calibre of some of its young people," said Mrs. Maynard Cooper, of Pelton in Drayton Plains.

Mrs. Cooper was referring to Randy Erb, 17, a senior at Clarkston High School.

The Coopers son, Kurt, who is 4 years old, is a hydrocephalic. This, in laymen's terms, means that he was born with a cyst covering his brain. This growth prevented the fluids from draining properly to his spine.

Corrective surgery removed the growth but created another serious problem. The surgery resulted in damage to an area of the brain which in turn brought on spastic cerebral palsy.

In spite of discouraging reports from the doctors, the boy has rallied and with the love and affection provided by a closely knit family of eight children and parents with a strong will and faith, he has made improvements that have surprised even the most optimistic.

In fact, Kurt learned so well it was necessary to get a special orthopedic chair and standing table to assist in his therapy treatment.

When the plan for the chair was found a neighbor of the Coopers agreed to find

somebody to build it.

The Clarkston High School has an Industrial Arts program in which they take great pride and so it was no great surprise that the neighbor went to them and they asked one of their more advanced students to undertake the project.

Randy Erb was the student who volunteered. He is 17 years old and will be a senior next September. He is a member of the National Honor Society.

volunteered. He is a member of the National Honor Society.

Randy took the plans which were provided by the Oakland County Society for Crippled Children and Adults and altered the plans to accommodate Kurt's specific circumstances with his own initiative.

When the chair was finished there were a few minor adjustments and the chair was installed at the Cooper home where it is now assisting in the job of training young Kurt.

Randy is the son of Mr. and Mrs. Kenneth Erb of Snow Apple Drive. He has 2 brothers, Rick, 19 and Ron 14.

"It seems like the least we can do for this young man," said Mrs. Cooper, "is to let the whole community know of his kindness and efforts in behalf of our son. We are very grateful."



Kurt Cooper, 4, sits in his specially constructed chair and standing table. The chair was made from specifications and altered to accommodate Kurt's special needs.

School Board names officers

The School Board for the Clarkston Schools held their organizational meeting on July 13. R. V. Weber was re-elected to the office of the presidency and Richard Funk was returned to the treasurer's post.

Walter Cattin was elected to fill the office of secretary. That office had been filled by Walter Wilberg who, after 14 years, did not place his name on the ballot to be returned to the Board when his term of office expired in June.

It was agreed that the time and date for monthly meetings remain the same. The meetings will be held at 8 p.m. on the second Monday of each month.

Board members will be paid \$150 a year, the same as in the past and depositories will remain the same.

In other action taken by the Board, salaries for the Secretarial staff and the General Custodial staff were ratified.

According to school administrators, the controversy regarding the employment of Richard Schadel, high school band instructor, will go to arbitration at the request of the Association. At the present time a list of arbitrators has been submitted to both parties. They are expected to indicate their preference by July 15.

COMPUTER PROGRAMMING

Pontiac Business Institute

PHONE: 333-7028

Mail this coupon today for Free complete catalog of PHONE 333-7028

NAME

ADDRESS

WATCH Sale & Service

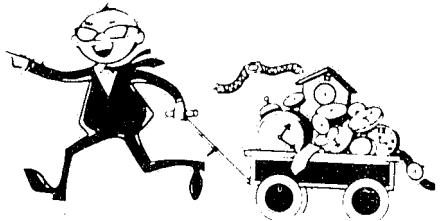

Dextrom Jewelers

4393 DIXIE HIGHWAY
673-1145

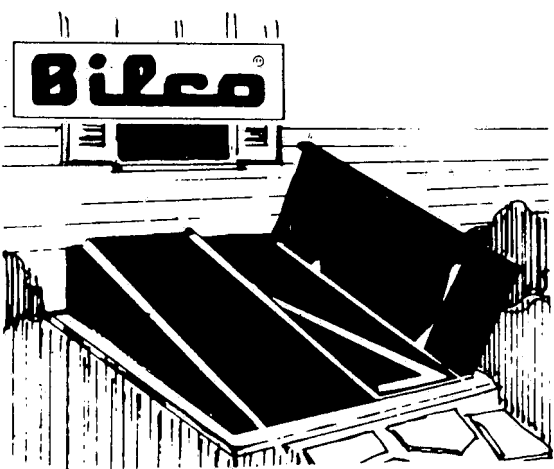

Add this beauty to your home

The BILCO Door is one home improvement idea that can claim to do both. It will add beauty and lasting value to your home . . . and save you money by eliminating the costly "over and over again" repair problems you have with your troublesome, wornout wood hatchway door. It pays for itself in a few years — and then keeps on serving you faithfully for the lifetime of your house.

Its smooth and easy operation, good looks and rugged construction will make you glad you decided now to move up to a new BILCO Basement Door.

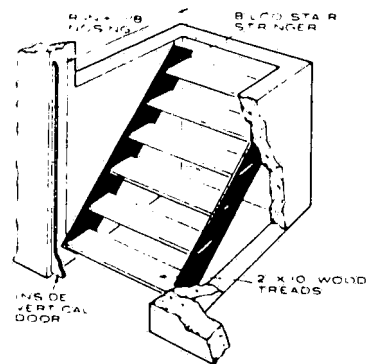

Deer Lake Lumber

7110 DIXIE HIGHWAY, CLARKSTON

625-4921

by george

How's that again?



Shel George

I never remember names, but I always forget a face. You know how it is. "Hey, I talked with ole what's his name yesterday. The guy who works with your Aunt's neighbor. His kid plays second base for the last place little league team. Yea, that's him. What's his name?" Just another faceless in a crowd.

Well, listen to this . . . Reginald Vanderblank Jr. used to be the butler at the Rothingham house. Spit and polish all the way. Proper diction, cleanliness, organized, sanitized and

galvanized for all I know. One couldn't ask for a better butler.

Ole Reggie did have one minor handicap however. It was his duty to announce all of the guests by name whenever Rothinghams threw a big shindig. Reggie fought an eternal battle in associating names with faces. You'd sympathize with him if you ever saw the length of the guest list. When the Rothinghams threw a shindig, they didn't mess around.

On the day of one of the bigger events,

Reggie was attending to his duties in his usual meticulous fashion. He could be heard going over the guest list in audible sequence.

"May I present Mr. and Mrs. Ignatz."

"May I present Mr. and Mrs. Smearcheese."

"May I present Mr. and Mrs. Finkbiner."

"May I present Mr. and Mrs. uh, uh, uh, . . . oh nuts!!"

"Mrs. Rothingham, Mam. Would you please refresh my memory concerning some of the guests. I'm having difficulty remembering the name of Mr. Rothingham's new business partner. Yes, the gentleman that recently joined the firm from the eastern office."

"Oh yes. Thank you. Lummuck. Spelled LOMACH."

Because of the difficulty in name and face association, Reggie often used the "helping crutch" routine. He would think of a common word that sounded like the name, and then concentrate on the

association. Lomach had a natural. The "helping crutch" would be stomach.

Lomach sounds like stomach. Lomach sounds like stomach. Lomach sounds like stomach. Reggie had whipped the difficulty.

The guests begin to arrive, late of course. That's fashionable. Reggie was at his usual. Did it up proud.

The guests of honor arrived too. They proceeded up the front porch stairs, rang the chimes, Reggie opened the door and bowed.

"Good evening." Turning around he announced to the waiting party, "May I present Mr. and Mrs. Kelly."

That's o.k. Reg, nice meeting you, too.

CLARKSTON NEWS
DEADLINE
News and Display Ads
5:00 p.m. Friday
Classified Ads
10:00 a.m. Tuesday

HERE NOW



AT PONTIAC STATE BANK

The No.1 Charge Card

The No. 1 Charge Card . . . BANK AMERICARD rates number 1 because it's honored more places for more things than any other card carried today . . . The largest all-purpose Charge Card Service with well over 23 million card holders and more than a half million participating merchants in services of all types, across the country and around the world . . . Bank Americard is many things . . . It is automatic approval for cash at any member banking office anywhere . . . Of course, it's the only credit card you'll ever need and it's here now at Pontiac State, so why settle for less than the world's largest?

For Complete Information Stop At Any Office of Pontiac State Bank

The Bank on the Grow
13 Convenient Offices to Serve You
Clarkston and Drayton Plains



Pontiac State Bank

CLASSIFIED * ADS

AUTOMOTIVE

CLARKSTON AUTO PARTS
625-5171 6 North Main
Open 9 to 9
New and rebuilt auto parts

25tfc

FOR SALE

3 TABLES: 2 End, 1 Coffee Table for only \$29.99. Choice of walnut, maple and marble finishes. Winglemire Furniture Store, Holly.

SINGER AUTOMATIC ZIG ZAG sewing machine - sews single or double needle designs, overcasts, buttonholes, etc. Modern cabinet. Take over monthly payments or \$56 cash balance. Still under guarantee. Universal Sewing Center. FE 4-0905.†††

DORIC TRANSISTOR ORGAN and Electro-Voice Microphone. Will sell cheap. Call 634-8134.†††46-1c

GARAGE SALE: 89 N. Holcomb, Friday & Saturday, July 17 and 18.†††46-1c

JUBILEE PLATE, by Bing & Grondahl: Issued only every 5th year. A collectors item. 25.00 Annual Plates 14.50. Boothby's, Dixie Highway and White Lake Road, Phone 625-5100.†††45tfc

TROPICALS GALORE
Tropical Fish and Supplies
Over 100 varieties
6561 Transparent Drive
Clarkston 625-3558
16tfc

FIREWOOD FOR SALE. Will do tree trimming and removal. Light trucking. Phone 625-4747.†††29tfc

GUARDSMAN CLEANING POLISH now available at Winglemire Furniture Store, Holly.

OVAL KITCHEN TABLE, 6 chairs. \$35. Very good condition. 625-2167.†††46-1c

DOUBLE D RANCH

FOR SALE: horses and ponies. Horse and pony equipment, wholesale. 4980 Clintonville. 673-7657.†††36-tfc

9 x 12 **HEAVY WEIGHT** Linoleum rugs. Only \$13.88. Winglemire Furniture Store, Holly.

NEW OWNER Y KNOT ANTIQUES, 4580 Sashabaw Rd., Drayton Plains. 2 miles south of I-75 exit. 10% off any item if you bring this ad with you before July 30.†††44-4c

BRUNSWICK slate pool table. Professional size. 6 cues, Belgium balls and wall rack. Can move. \$210.00. 255-4894 or 341-2757.†††44-4c

SINGER DELUXE MODEL - portable zig zagger, in sturdy case. Repossessed. Pay off \$38 cash or payments! 5 year guarantee. Universal Sewing Center. FE 4-0905.†††

CLOSING ESTATE: Thursday, Friday only, July 16, 17, 10 to 6, 5920 Lakewood, Clarkston, (on Dollar Lake, 1/2 mile North of M-15, one block east of US-10). Victorian bedroom, dining, parlor furniture, halltree, baby grand piano. Mission Oak tall clock, brass beds. Old china, glass, jewelry, trunks, tools, clothing, dry goods and millinery shop items. Lace, bead trims, etc. Mah Jongg set, other collectables, refrigerator and housewares.†††46-1c

FOR SALE

SOFA BEDS in several styles and colors. Save up to \$80 for cash and carry. Winglemire Furniture Store, Holly.

OUR SHRUBS, CONTAINER GROWN, can be planted all summer with no transplant shock. Variety of flowering shrubs, evergreens, birch and fruit trees. Noel Arbor Farms, 79 Park, Oxford. 628-2846.†††40-tfc

MERION BLUE SOD. Buy direct from farm. Deliveries made or you pick up. 4643 Sherwood, 628-2000.†††33-29c

PETS

MALTESE PUPPY: Champion sired, small, had all shots. Best offer. Must sell. 625-3624.†††46-2

LIVE STOCK

HORSE-PONY-AND EQUIPMENT SALE. Every Friday 7 PM. Live stock sale every Tuesday 2:30 PM Consignments welcome. Lapeer Stock Yards, Lapeer, Michigan. 678-2529.†††43-tfc

REAL ESTATE FOR SALE

4,200 FT. FRONTAGE on Waumegah Lake. Two miles northwest of Clarkston at Rattalee Lake and Chippewa Road. Some roads in. Will sell 1/3 acre pieces on lake and canal. If you like to rough it we have it. Will also sell complete parcel to a smart developer. Call collect, Sam Warwick, 682-2820 or 682-1714.†††44-tfc

ALL CASH
For homes any place in
OAKLAND COUNTY
Money in 24 HOURS
YORK
REAL ESTATE
WE BUY WE TRADE
Or 4-0363 Fe 8-7176

FOR RENT

NICELY FURNISHED ROOMS for rent, Dixie Highway near Davisburg Rd. 625-4347.†††46-1c

FOR RENT: Offices, also studio apartment in Motel building with heat, ground care and utilities. Unfurnished, reasonable. Dixie Highway. Phone McGaffey (Holly) 634-8761.†††46-1c

LAKE FRONT HOME, furnished, 1 year lease, no children, security deposit and one month rent in advance. Call after 7, 1-274-3674.†††45-3c

FOR RENT: new K of C community hall. Weddings and anniversaries. 300 capacity. For information call 625-5546.†25-24p

FOUND

FOUND: 1 Town & Country green heel. 625-3558.†††46-1c

FOUND: Items lost at day camp. 625-2102.†††46-1c

PAPER TABLECLOTH available at the Clarkston News Office. Just \$4.04 per 300 ft. roll. Ideal for parties, receptions and club dinners.

WORK WANTED

CARPENTER WORK WANTED. Some cement work, additions, basements, etc. 625-2752 or 628-4167.†††39-tfc

CARPENTRY, REMODELING and repair work wanted. Call 625-2268.†††39-tfc

WANTED

WANTED: a man to paint a cement wall. Ward Dunston, 4625 White Lake Rd.†††46-1c

SERVICES

CAVANAUGH'S TREE SERVICE - tree removal, land clearing, pruning specialists, spraying, bracing & cabling. Fully insured. 24 hour service for storm damage. Call 334-9049 or 335-4309.†††46tfc

FILL DIRT DELIVERED, Clarkston Village area. \$1.00 per yard in 100 yard lots. Phone 625-2331.†††49tfc

ARNOLD ELECTRIC - residential, industrial and commercial electrical services. Call Jim Arnold at 625-2225.†††39-tfc

CHAIN LINK FENCE installed or repaired. Free estimates. 338-0297 or 334-1251. Fast and inexpensive service.†††42-tfc

A-1 TOPSOIL, black dirt, shredded peat, road gravel - all sand and stone, products delivered. Phone 625-2231.†††36tfc

CEMENT WORK-Free estimate. Custom concrete. 625-5515.†††33-tfc

TRIPLE A-1 SOD. Laid or delivered. Call Clarkston Greens. 625-2122.†††34-tfc

GENERAL HANDYMAN, free estimates. Call 625-5624.†††44-4c

SCOTTY'S PLASTERING SERVICE. Plaster, cement & concrete repairs. Simulated brick & stone. Call OR 4-3467 and 625-2673 after 5 p.m.†††3-3tptfc

HELEN'S HAIRSTYLES: experienced, specializing in the latest hair fashions and permanent waving. 6 Church Street. 625-1610.†††44tfc

LAWN CUTTING with 42" rotary mower, 625-2784.†††44-3c

L & G DECORATORS, Interior and exterior. Painting, staining and lawn care. Free estimates anywhere. 338-2867.†††42-tfc

FIREPLACE, stone, brick, and block work done. Work Guaranteed. Free estimate. NA7-2482.†††43-tfc

CHAIN LINK FENCE, installed and repaired. One week service. Free estimate. Call 674-3961 43-4c

A-1 SERVICE. Basements, septic installation. Free dozing with 10 loads or more of fill. Call 625-3735.†††23-tfc

BEARDSLEE SAND AND GRAVEL. Also top soil, limestone and fill dirt. All areas and quantities delivered. Radio dispatched. 623-1338.†††34-tfc

WALLPAPER HANGING AND PAINTING, custom color mixing and staining, personal service. Bob Jensenius. 623-1309.†††46-11c

SERVICES

TREE TRIMMING, cutting and removal. Reasonable rates, free est., fast service. Call 693-4675 or 391-3156.†††46-6c

WEED CUTTING done with brushhog and tractor. Call 625-2288.†††46-3p

LIMESTONE, top soil and gravel products. 625-2628.†††37-12p

LEGAL NOTICE

William H. Stamp, Atty.
6188 S. Main Street
Clarkston, Michigan 48016
NO. 102,441
STATE OF MICHIGAN
THE PROBATE COURT FOR THE
COUNTY OF OAKLAND
Estate of Joseph H. Gidley, Deceased.
It is Ordered that on September 22, 1970 at 9 a.m., in the Probate Courtroom Pontiac, Michigan a hearing be held at which all creditors of said estate are required to prove their claims and on or before such hearing file their claims, in writing and under oath, with this Court, and serve a copy upon Joseph I. Gidley, 5902 Tubbs Road, Pontiac, Michigan - Administrator.
Publication and service shall be made as provided by Statute and Court Rule.
Dated: June 22, 1970
Donald E. Adams
Judge of Probate.

CARD OF THANKS

Many thanks to relatives and friends who stood by me through the long illness and death of my husband "Paddy DOnofrio." Many thanks for the beautiful flowers, food from the Eastern Stars. Special thanks to Rev. W. Howard Nichols, Lewis E. Wint Funeral Home, Michigan State Police and to the Visiting Nurses Association of Royal Oak.
His wife, Bonnie DOnofrio

Community Calendar

Thursday July 16

Cub Scout Pack 134
7:30 pm

Saturday July 18

Shirts "N" Skirts
Dance Club

Monday July 20

Rotary 6:30 pm

Tuesday July 21

Township Board 7:30 pm

Wednesday July 22

C. A. P. 7 pm

ACCESSORIES FOR THE WEDDING RECEPTION. Cake boxes, place cards, coasters, cake bags, place mats, ashtrays, stirrers. All available with name and date imprinted. Come in now and place your order at the Clarkston News, 5 South Main, Clarkston.

SAVE TIME - SAVE MONEY
USE WANT ADS
Phone 625-3370
before 10 a. m. on Tuesday



Happy Tuesday

by Jean Sura

Everybody knows that there are days when you should never get out of bed! Last Monday was my day. If you don't believe me — listen to this!

All Mondays are busy and can get pretty bad. A Monday after a four day weekend out of town visiting some old friends can shatter your health and leave you sapped of energy, poorly prepared to face the rigors of the day.

But on Monday morning I was fooled by the blue sky and sun shining in my eyes when I awoke. To add to my predicament, I had gotten to bed at a respectable hour and had slept soundly all night. I felt great.

I jumped out of bed with vigor. That was my first mistake.

Jumping on any morning is dangerous but after that four day weekend it was disastrous. Polking my brain back in through my ear I limped on my arthritic knee (an old war injury of course) into the bathroom. There, in the mirror, I surveyed the material I had to put together for the day ahead. The job seemed insurmountable.

The shower did its usual job of getting the old motor running. Rummaging around in the medicine cabinet I found some lotion to tame the itching of the spot of poison ivy I had contracted in the wilds of the Hillsdale Golf and Country Club.

Then I tied up my 'crows feet' and headed

for the office, where the day proceeded along its usual "Monday" course. I got blamed for things I hadn't done and blamed for things I had done.

The copy machine refused to copy, even after an overhaul. The typewriter ran out of carbon ribbon and had to be replaced. The headliner gnashed its gears and had to be taken apart.

I got new bi-focal glasses.

Bad for a starter, you say? Stick around. There's more.

When the long day finally came to an end I took the copy for the paper over to the print shop to be set. It was dark. I parked behind the shop. As I went to get out of my car my key-ring broke, showering the keys over the floor of the car. Most of them wedged themselves between the seat and the console.

I couldn't move the seat or turn on the lights because the motor was off and the ignition key with all the rest. I finally got them by squeezing my hand down in the narrow slot. The results were that I scraped the top off from the poison ivy blisters on my wrist.

You can guess for yourself what happened when I got in the darkened shop — anyway, I finally made it home. I sorted through the mail to relax.

There were three bills, no fun to read and then I got to the junk mail. One was

addressed to E. Serra, a sale flyer. The last was sent to E. Suro and there were three mistakes in the spelling of the street name. Very flattering.

This valuable message was an application for the American Association of Retired Persons. (Just what I needed.) For two dollars a year it offered me, 1. Money saving Drug Service, (Heroin maybe for Mondays.) 2. A low cost travel program, (Maybe I should hit the road.) 3. Low cost group health and life insurance, (I could never pass the test without help.) 4. Driver plan and Auto Insurance, (With keys on a solid ring, I hope.) and 5. Two publications.

At this point my new glasses slid and I focused through the wrong focal on the names of the magazines.

"Modern maternity" was what I thought I saw.

"Oh, my gosh, what is this world coming to now — Maternity magazines for retired people?"

A second look and I realized my mistake and breathed a sigh of relief. "Modern Maturity was the name.

I'm sending a message to the kind friend who submitted my name for all this valuable garbage.

It says you have to be fifty-five years old to qualify for all these benefits.

Many more Mondays and I'll never make it.

PEEKIN' into the PAST

25 YEARS AGO IN THE CLARKSTON NEWS

July 20, 1945

Mrs. Gordon Tower and Mrs. O'Roark returned on Thursday of last week from a seven days cruise on the Great Lakes on the S.S.N. American.

Joyce Lawson was a guest this week of Mary Edgar at the State Normal College at Ypsilanti.

Mr. and Mrs. Dewey Johnson of Dixie Highway are moving to their new home on Old Lane Road.

Thermometers in Clarkston registered 48 degrees early Wednesday morning, July 12th. (Brrrrr, Let's hope history doesn't repeat itself!)

10 YEARS AGO IN THE CLARKSTON NEWS

July 21, 1960

Mary Robbins and Linda Chapman will be home this weekend after finishing a four-week counselor training period at Camp Sherwood in Lapeer. Mary will return to the camp Monday to work the remainder of the summer.

Attending a party honoring the birthday of Miss Bobette Buehrig at her home on Overlook Drive were: Linda Hallman, Sue Hampshire, Skip Walker, Jennifer Pike, Mike Turek, Gary Pearson, Gladys Grey, Johnny Williams, Randy Armstrong, Bob Mathewson, Connie Papi, Larrie Walter, Mike Stevens, Tom Weber, Carol Sage, Steve Parrot, Cricket Embrey and Danny Waggoner. All had an enjoyable evening, dancing, eating pizza and watching Bobette open many lovely gifts.

Friends of Sally Moore will be glad to hear that she is now home and recovering quickly from a throat ailment which sent her to the hospital.

Graduations keep family busy

John and Mary Ann Yasaitis, son and daughter of Mr. and Mrs. John J. Yasaitis of Baldwin Road, received degrees within the same week.

Mary Ann was awarded a B. A. degree in physiology from the University of Wisconsin.

In the same week, her brother John, received double degrees from the Massachusetts Institute of Technology. His Bachelor of Science degree was in,

electrical engineering and he received a Master of Science Degree in metallurgy and materials science.

John was a member of Chi Phi Fraternity and on the heavy weight rowing crew. He has been accepted as a teaching assistant on a doctoral program at the Institute.

Both Mary Ann and John graduated from Lake Orion Community High School.

More and more people in Independence Township are reading the News for news of this area. Just \$4.00 a year in Michigan. Call 625-3370.



'65 MERCURY Caliente, 2 dr. hard-top, V-8, AT, sport steering wheel, burgundy finish, economical transportation, \$895

'66 IMPALA Wagon, V-8, AT, P.S., P.B., tires are like new. Beautiful teal blue finish. \$1295

'67 CHEVY Caprice, factory air cond., V-8, AT, P.S., P.B. Drive in air conditioned comfort, \$1695

'67 FORD Galaxie 500, very very clean, still under factory warranty, V-8, AT, P.S., P.B., must see, \$1495

'69 CHEVY Belair, V-8, AT, P.S., factory air conditioning, still under factory warranty, \$2295

'65 CHEVY 1/2 Ton Pickup, V-8, automatic transmission, custom cab, tutone paint, Hard-top, suspension; real nice, \$895

RADEMACHER

CHEVY-OLDS

—BIG LOT BIG BARGAINS—

6751 DIXIE HIGHWAY

625-5071

Around the Town

Stroke, stroke

By Doje

The following brave couples left Friday afternoon in a downpour and traveled to Mio where the weather man was with them. He provided a beautiful two days for their canoe trip down the Au Sable. They paddled 22 miles to McKinley where they camped. From all reports everyone had a good time. How could they help it, good weather, good friends, and I am sure, many, many good laughs.

The paddlers were the B. J. Hansons, Ralph Kenyons, William Dennises, Don Mautis, Paul Rakows, Dave Coutures, Mel Masons and Ronald LePeres.

Happy Birthday to Bev Hanson who reached the ripe old age of 17 on July 14. Bev is the daughter of Mr. and Mrs. B. J. Hanson of Snowapple Drive.

Mr. and Mrs. Richard Blasey of Holcomb Road, held a four and five generation get-together at their home last Sunday. Members of the five generations were: Mrs. William Cook of Central Lake, Mrs. John Cameron of Bradley, Illinois, Mr. Dick Blasey, Mrs. Randy Armstrong, Stephen and Megan Armstrong all of Clarkston.

The four generations included Mr. and Mrs. Jack Bosworth, Mrs. Dick Blasey, Mrs. Randy Armstrong, Stephen and Megan Armstrong of Clarkston. The Jack Bosworths are from Central Lake.

Dr. and Mrs. Robert Buehrig of Reese Road received several "pluses" for the 4th of July. First was transcontinental phone call from Lisbon, Portugal, from their youngest daughter, Mrs. Robert (Heidi) Bass. She and her husband are touring Europe. Their itinerary includes London, Paris, Rome, Athens, Vienna, Munich and Amsterdam.

The second plus was that daughter Bobette and husband David Coulter, visited for the holiday.

"Chipper" Buehrig participated in Spring Lake Country Club's 3rd annual National Invitational Junior Golf Tournament and then returned to Kalamazoo with the Coulters for the week during which time he will go to Jackson to be with his brother, Chris and family.

Mr. and Mrs. Stanley Roosa and sons, Doug and Dave of Eastlawn, entertained 39 friends and relatives on the 4th of July at their cabin which is under construction at Bear Lake.

The cabin was not completed enough to protect one from the rain but it sure held out the high winds which were coming inland from the lake.

The cabin is located next door to Mrs.

Roosas' parents home, Mr. and Mrs. Al Kuenzer who were formerly of Drayton Plains.

Lisa and Lori Irwin, twin daughters of Mr. and Mrs. Clifford Irwin of Laurelton, were baptized on Sunday, July 5, at the United Methodist Church, Clarkston. The Irwin's opened their home to friends and relatives on Sunday afternoon.

Sally Kenyon, daughter of Mr. and Mrs. Ralph Kenyon of Holcomb Street, spent her second birthday with her grandparents, Mr. and Mrs. W. C. Kenyon of Battle Creek. She and her brothers were weekend guests, while sister Jane was at camp and mom and dad joined 7 other couples on a canoe trip.

Scott Anderson of Snowapple Drive, son of Mr. and Mrs. G. W. Anderson, had a rainy 9th birthday on July 10. He had planned on taking his birthday cake to the Little League game and sharing it with his team mates but the game was rained out. Better luck next year, Scott.

Happy Anniversary to Mr. and Mrs. Paul Bennett who celebrated their 7th on July 13.

The cheering heard in the yard of Bob and Marietta Jones of Robertson Ct. Saturday night was that of 12 couples enjoying a lobster race. The poor lobsters had to race and still ended up in the pot. How mean can you be?

Mr. and Mrs. Robert Waters have returned home after two weeks at their cottage on Lake Michigan.

Mr. and Mrs. Donald Reene of Eston Road hosted an open house on Sunday, July 12. It honored the 25th anniversary (on July 14) of Mr. and Mrs. Earl Bailey of Main Street Clarkston. Twenty friends and relatives joined the celebration.

Mr. and Mrs. Randy Armstrong of Davisburg Road are the proud parents of a baby girl born June 30. The baby has been named Megan Danielle. Eagerly awaiting her arrival home was brother, Stephen Daniel. Grandparents are the Leo Armstrongs and Richard Blaseys of Clarkston.

ACCESSORIES FOR THE WEDDING RECEPTION. Cake boxes, place cards, coasters, cake bags, place mats, ashtrays, stirrers. All available with name and date imprinted. Come in now and place your order at the Clarkston News, 5 South Main, Clarkston.



Partners in the Pine Knob School Michigan study of Holland, during the fourth graders' Dutch Shoe Dance program are Darlene Lay and Ronald Powell.

Fair time at St Marys

Mrs. E. O. Thomson of North Main Street is the publicity chairman for the 17th Annual Country Fair that is sponsored by St. Mary's-in-the-Hills Episcopal Church.

This year's Fair, according to Mrs. Thomson, will be held on the church grounds at 2512 Joslyn Road, just south of Antique Village, from 11 a.m. to 7 p.m. on July 18.

The auction will begin at noon. There will be many colorful booths, among them, the Country Cupboard and Gourmet Goodies. Fire engine and helicopter rides will be a special feature.

Snacks will be available as well as a Chuck Wagon Dinner.

The proceeds from the Fair will be used to support the church. The public is invited to attend.

Dean's list

Vickie J. Swartz, of 6953 Tappan, was among 137 Flint University of Michigan students who were named to the Dean's List during the 1970 spring semester.

The Flint M Dean's List is comprised

of freshman, sophomore, junior and senior level students earning a 3.5 or better grade average, based on a 4.0 for an A.



By Jean Sura

If you are staying home this summer why not try a menu that will take you away from it all. The Ford Times Magazine has compiled a collection of famous recipes from popular American restaurants. Let's start out in the Northeast. This one is from the Mediterranean, North Truro, Massachusetts.

SPINACH OMELET

1½ tablespoons olive oil
2 tablespoons chicken stock
1 package frozen whole spinach
Pepper to taste
½ teaspoon salt
1 clove garlic chopped fine
4 tablespoons freshly grated Sardo or Parmesan Cheese
10 eggs
2 tablespoons water
2 tablespoons butter

Place oil and stock with spinach in saucepan. Break up spinach. When spinach has softened add pepper, salt and garlic. Simmer gently for 20 minutes. Add cheese, stir and simmer 5 more minutes. Beat eggs and water lightly in a bowl, add pinch of salt and pepper; melt butter in a 10 inch skillet and when butter is hot pour in beaten eggs. Keep moving wet mixture in from edge with a spatula until all the egg mixture is almost cooked. Spread spinach across half of omelet and fold other half over it. Turn omelet out onto a warm dish and serve immediately. Serves 4.

Here is one from the Wayside Inn, in South Sudbury. The restaurant was described by Longfellow and was

purchased by Henry Ford in 1923.

WAYSIDE INN CHICKEN PIE

Cut up a 4-5 pound stewing hen and place in a kettle. Cover with boiling water. Add to kettle: a couple of sprigs of parsley, 3 to 4 stalks of celery with leaves on, 1 whole carrot, 1 slice onion, 1 tablespoon salt and a dash of pepper. Bring to a boil for 2 minutes, then lower heat and simmer gently for 2-3 hours. Cool, then remove meat from bones in large pieces. Place chicken pieces in 1 large casserole or 6 individual casseroles. Add 2 cups pearl onions and ½ cup of peas. Strain broth and to each 4 cups of broth add ½ cup of flour combined with 1 cup of milk to form a paste. Cook until thickened. Season with salt and pepper to taste. Add to casserole. Cover with pie crust or a rich biscuit dough and make large slits in crust. Bake at 450 degrees 'til crust browns and serve at once. Serves 6 to 8.

While we're out there why not try this Baked Indian Pudding from the Olde Grist Mill in Kennebunkport, Maine.

BAKED INDIAN PUDDING

Pour 2 cups scalded milk on 1/3 cup corn meal. Cook in double boiler for 20 minutes. Add ½ cup molasses, ½ cup sugar, ¼ cup butter, 1 teaspoon salt and 1 teaspoon ginger or cinnamon. Pour hot mixture into buttered pudding dish, then pour in 2 cups cold milk. Do not stir. Set in a pan of hot water and bake 3 hours in 250 degree oven. Top warm pudding with ice cream or with sweetened whipped cream. Makes 6 generous portions.



SLIPS

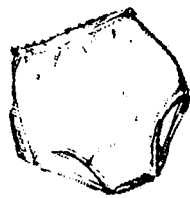

PANTIES



ELAINE MANN - INSTRUCTOR

WHAT'S NEW? - Lessons in sheer delight! Lingerie sewing... it's easy! It's fun! It's economical! Special classes teaching the techniques of sewing on tricots, lycras, and stretch knits. Now scheduling day and evening classes.

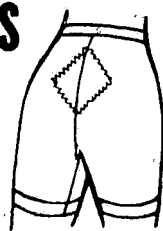

GIRDLES

Jan's Sewing Basket

12 S. Main

Registration & deposit required

625-2422



Mrs. James B. Rausch

Wed in Lansing

The Reverend Raymond Goehring performed the July 10 ceremony that united Sally Jo Elliott and James Bernard Rausch in marriage at the St. Thomas Aquinas Church in East Lansing.

The bride is the daughter of Dr. and Mrs. Jack C. Elliott of East Lansing and the groom is the son of Mrs. I. B. Rausch of Cranberry Lake Road and the late Mr. Rausch.

Mrs. Charles E. Day of Edgewood, Maryland, was her sister's matron of honor. Bridesmaids were Mrs. Gary Gillespie, Ann Arbor, Roberta Hendrick, Champaign, Illinois and Mary Grubb, Kalamazoo. They were gowned in mint

green organdy and carried daisies.

William Rausch was his brother's best man. Ushers were: Michael J. Feliksa, Waterford, John B. Rowell, Lansing and Brian LaLone, Rochester. The five year old nephew of the groom, Patrick M. Rausch was the ring bearer.

A candle-light buffet at the Jack Tar Hotel in Lansing followed the ceremony.

The newlyweds will make their home in Lansing where the bridegroom will continue his study of Veterinary Medicine. The bride, who is a MSU graduate, will teach English at Holt High School.



Mrs. John A. Strohkirch

Garlak-Strohkirch exchange vows

A double ring ceremony united Karrie Lee Garlak with John A. Strohkirch on July 4th. The Reverend Frank Cozadd performed the service before an altar decorated with candles and baskets of mums at the United Methodist Church of Clarkston.

The bride is the daughter of Mr. and Mrs. John M. Garlak of Deer Lake Road, and Mrs. Lillian Strohkirch of Waldon Road and Mr. Herbert Strohkirch of Rochester are the parents of the groom. Tammy Mahar was the maid-of-honor

and Laura Willits, Sue McAnally, Cindy Porrett and Debbie Longstaff were the bridesmaids. They were gowned in a rainbow of summer pastels and wore matching picture hats.

James Chenowith was the best man and Raymond Chenowith, John W. Garlak, the bride's brother, John Stuart and Hugh Brockman were the ushers.

A reception for 250 guests was held at the F.O.E. Hall on Dixie Highway.

The newlyweds traveled to Norfolk, Virginia where the groom is stationed with the United States Navy.

To live in Ann Arbor

Mr. and Mrs. Howard Kieft of Sagamore Drive recently announced the marriage of their daughter Carol Marie to Andre Wilkenson Furtado. He is the son of Mrs. Unc Narichana of Bombay, India.

The June 20th ceremony was performed by Father Charles Irwin at the St. Mary's Student Chapel in Ann Arbor.

The newlyweds greeted their guests at the Green Briar Club and then left for a honeymoon trip in Northern Michigan.

They will make their home in Ann Arbor where the groom is completing work on his PHD Degree in Chemical Engineering and the bride will continue to work in her art studio.



Mrs. Ronald W. Owen

Yellowstone Honeymoon

Patricia A. Bishop and Ronald W. Owen, classmates at Ferris State College, spoke their marriage vows at the United Methodist Church of Clarkston on July 11 before 200 guests.

The bride is the daughter of Mr. and Mrs. Curtis Bishop of Middle Lake Road, and Mr. and Mrs. Lee Owen of Iron River, Michigan, are the parents of the groom.

The bride's sister, Sharon was the maid of honor. Matron of honor was Mrs. Rodney Scott of Drayton Plains. Mrs. Edward Brandel of Saginaw, the groom's sister, Sandra Owen of Iron River and Susan Burger of Imlay City, were the

bridesmaids. All the bride's attend were gowned in dotted swiss turquoise taffeta and carried seas flowers.

Melissa Kee was the flower girl. Gary Owen served as his brother's man. Edward Brandel, Russel Thurs Mark Stromberg and John Magray v the ushers.

Immediately following a reception at the Independence Township Hall the couple left for a two week trip to Yellowstone Park.

They will make their home in Saginaw where they are both employed.

Letters from Marguerite



by Marguerite Slater

Dear Jeanie:

As I got out my typewriter God began to throw down lumber which threw me entirely off the things I had in mind. So as long as the weather is too hot for my original plans, I'll get on to the lumber.

My mother was terrified of thunder when she was little so her grandmother assured her that there was nothing to fear as it was only God throwing down lumber.

Paradoxically, at age 7, she lay in a coma for 3 days, her survival very much in doubt, after she and 4 other children were struck by lightning in their school-room. Then when she was 15, while watching her uncle trying to catch a frisky horse during an electrical storm, he was killed by a bolt of lightning right before her eyes! She was inside her house fortunately.

As a consequence, my brothers and I, during a bad storm, were always herded into a spare bedroom which was equipped with a huge featherbed.

My Aunt Em not only always slept

on a featherbed but if a storm came up in the night, she put on a pair of rubbers she kept for that protection only. She was five years older than my mother and so was duly impressed by the power of lightning.

Aunt Em and her husband, my Uncle Jim, had a lovely fruit farm just outside our small town and I can remember the hot arguments when electric service was extended into their area. Uncle Jim had a tough time convincing Aunt Em that electric lights wouldn't "draw" lightning.

Their house was the joke of the community as the lightning rod salesman must have had a field day equipping that place with rods - it really bristled. It must have cost Uncle Jim a pretty penny to get his lights and also keep Aunt Em from connecting with a bolt of lightning.

I have been grateful that my attitude toward that heavenly ire remains sensible; I don't "tempt" lightning but neither do I panic.

This Aunt Em was an excellent cook

and along with wonderful cooking smells, she always had 2 or 3 other projects going, all of which contributed to many happy remembrances of lovely odors.

Do you know that wonderful smell of green corn drying in the attic, spread out on big frames covered with white netting?

One combination just too heavenly to ever forget was the time I spent a few days visiting there and Aunt Em was drying corn in the attic, drying lavender on the back porch and making raspberry jelly! The jelly smell would have been enough sheer pleasure, wouldn't it?

Jeanie, this letter is turning into an exercise in whiffs and sniffs from the gay 1900's—and here I sit calmly pounding away defying the bolts and lumber which are rampant right now so

I'll "ring off" as we used to say so cleverly.

Your old friend,
Marguerite

75c Value **FREE** 75c Value

18 Holes of Golf PUTT-PUTT

Lights for Night Play
Open 9 A.M. till 12 P.M.

3580 Dixie Highway
Loon Lake - Drayton Plains
1 1/2 Miles from Telegraph

"One Free with

75c Value One Paid 75c Value
674-4116

Clarkston News

RICHARDSON'S FARM DAIRY STORE Ice Cream and Coffee Shop

Try Our Baked Goods, Hot Coffee and Delicious Sandwiches or Ice Cold Soft Drinks.

Home Made Bread 5/99c

Specializing in Catering to Banquets,
With Special Ice Cream Orders Taken for Parties.

Watch for our Grand Opening of our Grill.

Open Monday - Saturday 8:00 a.m.-10:00 p.m.

Open Sunday 10:00 a.m.-10:00 p.m.

PHONE 625-3900

10 S. MAIN ST. CLARKSTON



TOP Quality Always!

TRY RUDY'S

Pork Sausage

LB. 69¢

WHOLE

Chickens

LB. 35¢

MIRACLE WHIP

Salad Dressing

QT. 59¢

MEADOWDALE

Potato Chips

14 OZ. 59¢

STARTER

Char Coal

QT. CAN 39¢

Briquets

10# BAG 89¢

DEC. TOWELL

Gala

2 LG. ROLL 43¢

HADLEY

Butter

LB. 74¢

Porritt Milk

GALLON 89¢

VELVET

Ice Cream

1/2 GAL. 79¢

OPEN PIT

Bar-B-Que Sauce

28 OZ. 63¢

FROZEN

Orange Juice

5/6 OZ. 99¢

FROZEN

Strawberries

3/10 OZ. 85¢

Gr. Peppers-Cucumbers



3/ 29¢

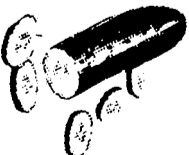

HEAD

Lettuce

LG. SIZE 2/49

Radishes-Gr. Onions



3/ 29¢



RUDY'S MARKET

9 South Main

625-3033

"Take two aspirin"

by Haslett Hemmor



First of all, like the guy says, let me make it clear I got no personal kick about unions. Like as not, if our garage was a scab shop I'd be making maybe a third less take-home.

Thing that sets a fellow wondering though, is where it's all going to end. Every year the union leaders got to prove that they're earning their 25 to 50 grand salaries by telling the boys that they're going to fight dirty old management and to get 'em another buck or two an hour to offset the old cost of living rise.

So the mechanics and the plumbers and the factory fellows all threaten to strike unless the poor overworked and underpaid union members get their fair share.

Long as sales hold up, the big shots figure what the heck, and knuckle under because all they got to do is boost the sales prices like all their competition does.

Kind of looks, howsomever, that maybe Joe Public has about got a belly full of prices going up, up and up. Take houses as a for example.

Near's I can remember, a good rule of

thumb a few years back was you could build a pretty good new shack for a little under ten bucks a square foot. Now it's maybe \$22, and nobody's real hot to trot for financing dough or even real anxious to build her if you can con some banker into a 9% mortgage, that's providing you got half to a third of the whole bundle to plunk down for starters.

'Course if you want something fancy like a closet or wallpaper in the living room, she's gonna run a mite more.

Take a character what's got three-four kids. Really needs a four bedroom joint, and they come very dear. Say that by squeezing a four bedroom job, kind of skinny but still four bedrooms, totals out to 1,350 feet. Get by for \$30 thousand and you're lucky.

Used to be that only bank presidents, and brain surgeons could afford a 30 thou' mansion. Now that's peanuts, and your hot shot young executives don't dare show how poor they are by living in such a tiny-tack dump. your hot shot young executives don't dare show how poor they are by living in such a ticky-tack dump.

Ridiculous part is that even at the eight or nine bucks an hour that electricians and plumbers get, they can't afford — mostly they can't even finance — a new house big enough for a family with two or three kids. They sure pop can't. When they was making maybe a third that much, they could buy a good new house and eat pretty good besides.

So maybe they better strike for \$12 or \$14 an hour so what's now a \$30 thousand house goes up to \$40 thou' and they can't afford that either.

Got no real sense for figures, and a real wheeler-dealer economy expert I'm not, but sure seems like some of these here government gents that's so all fired smart could do a better job of finding the answer and come up with a program to balance things out to help the little guy.

Everybody is so busy blowing his own horn that about the only answer that a guy with a family gets is, "Did you ever hear of the pill?"

Isn't that a crumb-bum way to figure out a national financial mess? Besides, in a couple years nobody will be able to afford pills.

When you buy a used car
at Haupt Pontiac

**THE SAVINGS ARE NOT
PEANUTS**



-Save more than peanuts



1965 OLDS VISTA CRUISER

9 passenger wagon with power steering and brakes. Radio, heater, automatic, and new white wall tires. Only \$1095

Visit our lots, view and drive one of our cars,
get our deal

Jack W. Haupt Pontiac Sales, Inc.

North Main, Clarkston
625-5500



Cindy Booker, 15, of Holcomb Road captured 1st place in the girls 14-15 division of the 3rd Annual Spring Lake National Junior Invitational Golf Tournament. She shot 87-92-179 to beat Valorie Patrick of Jackson by 1 stroke.



Vivian Booker, 12, took honors in the 12-13 year division with a steady 114-114-228. Her closest rival was Terri Figg of Mt. Pleasant with 232.



Mary Jane Anderson, 11, shot a sharp 132 with rounds of 64-68 in the 11 years old and under division to capture 2nd place. She was beaten by Cindy Figg of Mt. Pleasant who shot a 119.



Allison Booker, in her first round of competitive golf, won the consolation division of the 12 and 13 year division in the recent Spring Lake Junior Invitational.

Home Maintenance Directory

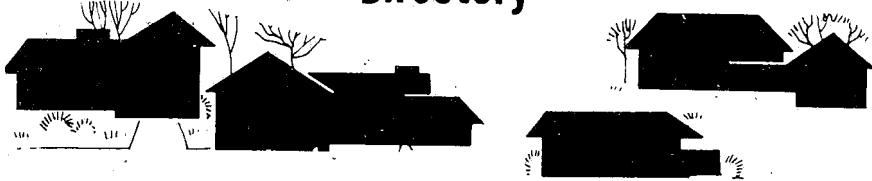

★ CHARLES A. SCOTT & SON ★ EXCAVATING

- *BASEMENTS
- *BULLDOZING
- *STUMP REMOVAL
- *FILL DIRT
- *GRADING

PHONE **625-5555**
5450 MARVIN ROAD
CLARKSTON

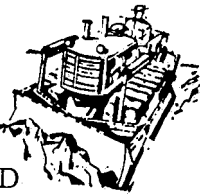

Henning's Maintenance Co.

MOBILE WASHING



PORT-A-WASH



Portable facilities available for washing your mobile homes, home sidings, trucks, car lot autos and industrial equipment.

STEVAN HENNING **625-3867** 6201 Ascension

ODD LOT SALE ALUMINUM SIDING

AS LOW AS . . . **\$12** PER SQUARE

Savoie's MAINTENANCE FREE HOME CENTER
64 S. MAIN, CLARKSTON 625-4630

MOON VALLEY RUSTIC FURNITURE CO.

PICNIC TABLES & LAWN SWINGS

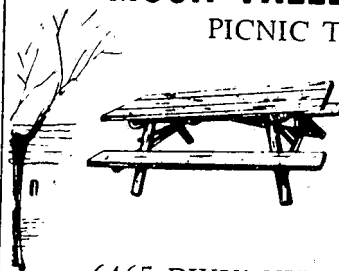

- 3 PLY SWING
- 2 PLY SWING
- CHAIR
- SETTEE

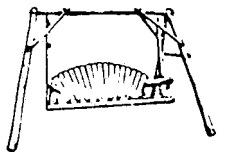

6465 DIXIE HIGHWAY 625-3322

Install New Fencing

Add protection to your yard, increase your property's value with a new fence. Many styles and materials to pick from.

-SECURITY FENCE-

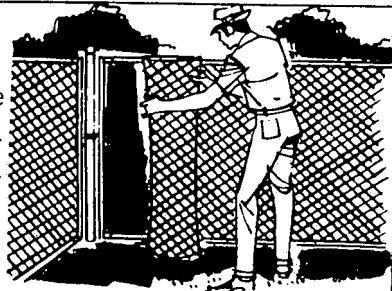

5451 DIXIE HIGHWAY, WATERFORD 623-0000

WHY MOVE? EXPAND YOUR HOME INSTEAD

Savoie's HOME CENTER MAINTENANCE FREE

64 S. MAIN, CLARKSTON 625-4630



OWENS-CORNING EMBOSSED ACOUSTICAL

CEILING PANELS

89¢ EACH
24 X 48 X 5/8

Savoie's

MAINTENANCE FREE HOME CENTER

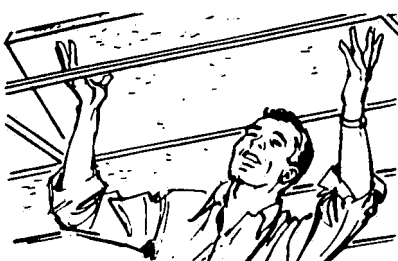

OXFORD MINING CO.

WASHED

SAND & GRAVEL

A. L. VALENTINE
Owner

- FILL DIRT
- FILL SAND
- MASON SAND
- TORPEDO
- STONE
- ROAD GRAVEL
- CRUSHED STONE
- PEA PEBBLE

- ★ WHITE LIMESTONE
- CUT FIELD STONE
- MASONRY SUPPLIES

625-2331

DELIVERY SERVICE

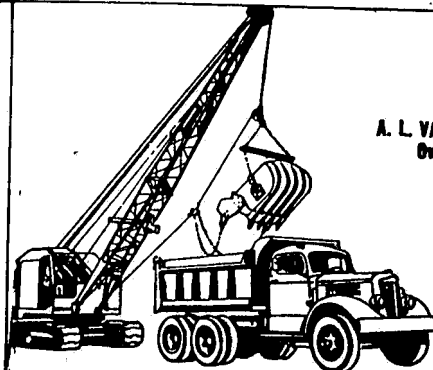

9820 ANDERSONVILLE RD., CLARKSTON